

ANALOG & DIGITAL COMMUNICATION

THEORY-3



PNSSCHOOL OF ENGINEERING & TECHNOLOGY

Nishamani Vihar, Marshaghai, Kendrapara

LECTURES NOTES

ON

ANALOG AND DIGITAL COMMUNICATION (THEORY-3)

DEPARTMENT OF ELECTRONICS & TELECOMMUNICATION

5TH SEMESTER

PREPARED BY

Er. AMARENDRA SAHOO

H.O.D., ELECTRONICS & TELECOMMUNICATION

CONTAINS OF CHAPTER-1.

Unit-1: Elements of Communication Systems.

1.1 Communication Process- Concept of Elements of Communication System & its Block diagram

1.2 Source of information & Communication Channels.

1.3 Classification of Communication systems (Line & Wireless or Radio)

1.4 Modulation Process, Need of modulation and classify modulation process

1.5 Analog and Digital Signals & its conversion. 1.6 Basic concept of Signals & Signals classification (Analog and Digital) 1.7 Bandwidth limitation

INTRODUCTION TO THE COMMUNICATION SYSTEM

Definition of communication system

The process of sending , processing and receiving the signal/information by electrical means is called as communication system.

❖ INTRODUCTION:-

➤ Communication is the process of establishing connection or link between two points for information exchange.

➤ (OR) It is the process of exchange of message / information / data from sender to receiver is known as Communication.

➤ The electronics equipments which are used for the communication purpose are called communication equipments. Different communication equipments are assembled to form Communication System.

➤ Typical communication systems are mobile communication, radar communication, fiber optics

Communication , satellite communication, telecommunication, television broad casting, radio broad casting, radio aids to navigation and radio aids to aircraft landing etc.

➤ Depending on the message we may divide communication into two parts:-

(A) Line communication

(B) Wireless communication

➤ In line communication, the messenger is electric current but in wireless communication, it is in the form of radio signal or EM wave.

→ Point-to-Point channels are wire lines; micro wave may be a pair of wires (in case of Line comm.) or may be open space (in case of Radio comm.).

→ Channel means the medium. It provides the intermediate link between the Transmitter and Receiver.

Noise: - During the process of transmission & reception the signal gets distorted due to noise

introduced in the system. Noise is an unwanted signal which tends to interfere with the required signal.

Noise has its greatest effect on the signal in the channel.

Receiver:-The main function of the receiver is to reproduce the message signal in electrical form from the distorted received signal.

Destination: - Destination is the final stage which is used to convert an electrical signal into its original form and it is fed to the loud speaker, television picture tube, computer or fax machine etc to get the required form of the input signal.

❖ **SOURCE OF INFORMATION: -**

➤ Some of the important sources of information in the communication environment may be listed as Speech, Music, Pictures, Computer Data.

➤ A source of information is basically a signal which carries the information.

SIGNAL

➤ A Signal may be defined as the single valued function of time. Time plays the role of an independent variable. This means that at every instant of time, the signal has a unique value.

CLASSIFICATION OF SIGNAL : -

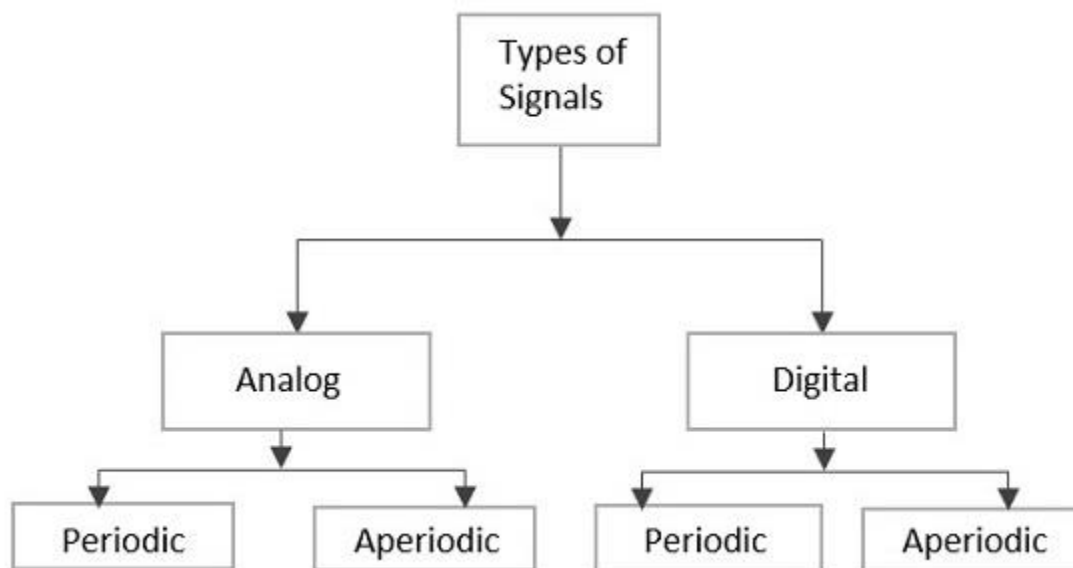

✓ **SPEECH : -**➤ Speech involves transfer of information from the speaker to the listener. Such a transfer of information takes place in the following three stages : - Production, Propagation & Perception

✓ **MUSIC: -**

- Music signal is originated from the instrument like Piano, Violin etc.
- The musical may be a short time or longer time depending upon the instrument being used.
- Music has two Structures : - 1) Melodic & 2) Harmonic
- The Melodic structure consists of a time sequence of sound where as the Harmonic structure consists of a set of simultaneous sound.

✓ PICTURE: -

- The picture can be either Static or Dynamic.
- The picture sent by fax machines is example of a Static Signal where as the picture produced on TV is an example of Dynamic Signal.

✓ COMPUTER DATA : -

- Personal Computers are used for electronic mail, exchange of software and sharing of resources.
- The text matter transmitted by a computer is encoded using ASCII code.
- Computer generated data and Television signals are both wide band signals in that their power content.

occupies a wide range of frequencies.

❖ COMMUNICATION CHANNELS: -

- The medium over which the information is passed from the transmitter to the receiver is called as COMMUNICATION CHANNEL

CLASSIFICATION OF COMMUNICATION CHANNEL:-

- Some of the important characteristics of a channel are : -
 - ✓ Power required to achieve the desired S/N ratio (Signal to Noise ratio)
 - ✓ Bandwidth of the Channel
 - ✓ Amplitude and Phase response of channel
 - ✓ Type of Channel (Linear or Non-linear)
 - ✓ Effect of external interference on the channel
 - ✓ CLASSIFICATION OF COMMUNICATION SYSTEM -

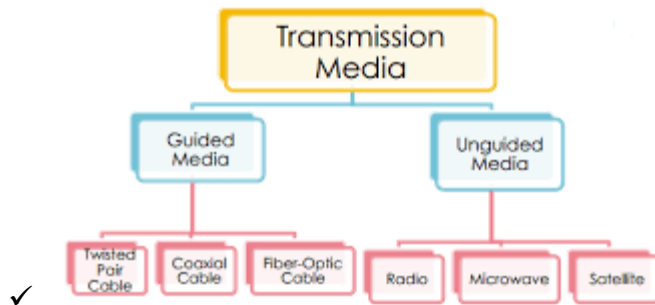

❖ ELEMENTS OF COMMUNICATION SYSTEM: -

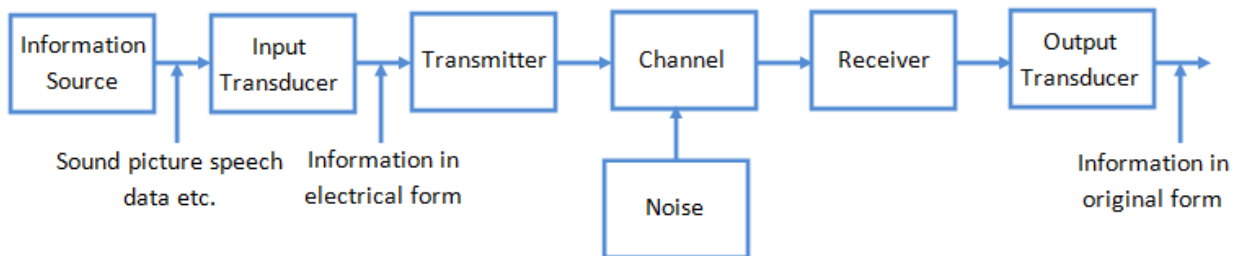

BLOCK DIAGRAM OF COMMUNICATION SYSTEM

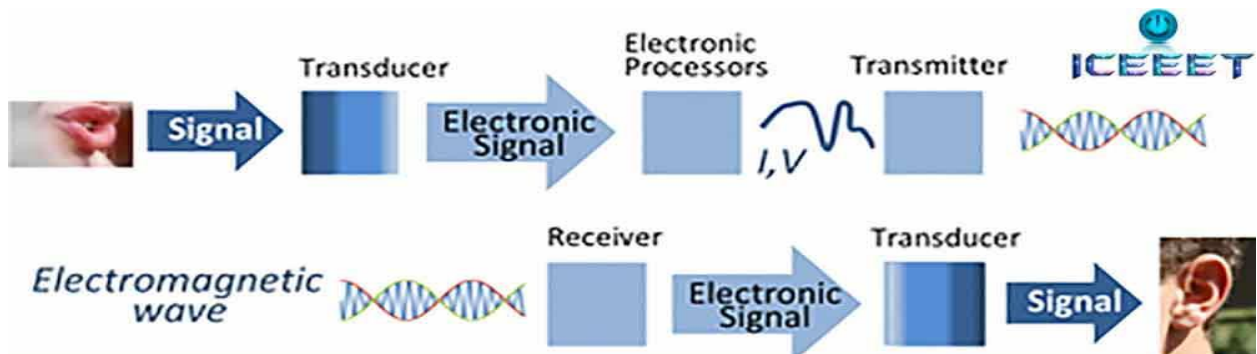

Basic Communication System-Elements | Its Applications | Block Diagram

- In the most fundamental sense, communication involves the transmission of information from one point to another through successive processes.
- The block diagram of general communication system in which the different functional elements are represented by blocks. The essential components of a communication channel, receiver and destination.

Message/Information Source: -The information or messages which are to be transmitted comes from message Source. In general, there can be various messages in the form of words, group of words, code, symbols, sound signal etc. However, out of these messages , only the desired message is selected and

conveyed or communicated. In short the function of Information source is to produce required message which has to be transmitted.

Input Transducer: - A Transducer is a device which converts one form of energy into another form.

The message from the information source may or may not be electrical in nature. In the case when the message is not electrical in nature, an input transducer is used to convert into electrical signal.

Transmitter:-The function of a Transmitter is to process or modifies the message signal and makes it suitable for efficient transmission. Mainly Modulation and Amplification are achieved in transmitter.

Transmitting Channel: - Channel means the medium through which the message travels from transmitter to the receiver. In other words the function of channel is to provide a physical connection between the transmitter and the receiver. There are two type channels, namely point-to-point channel and broadcast channels.

❖ COMMUNICATION SYSTEMS: -

➤ The electronics communication systems may be classified into various categories as shown in fig.

➤ It shows that electronics communication system may be basically categorized into 3 groups based on :

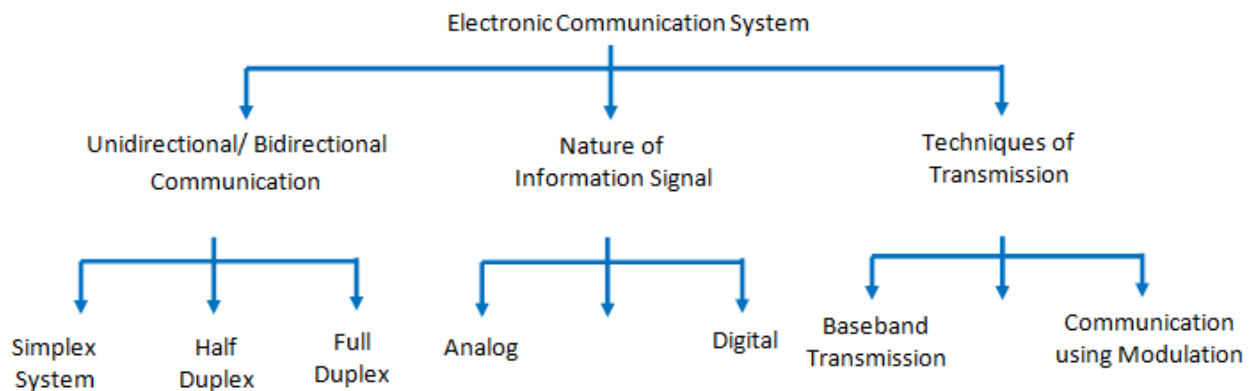

- ✓ Whether the system is Unidirectional or Bidirectional.
- ✓ Whether it uses an analog or digital information signal.
- ✓ Whether the system uses base band transmission or uses some kind of modulation.

➤ In these systems, the information is communicated in only one direction.

➤ For example, the radio or TV broadcasting system can only transmit. They cannot receive.

➤ Another example of half duplex system is the information transmitted by the telemetry system of a satellite to earth.

HALF DUPLEX SYSTEMS: -

➤ These systems are bidirectional i.e. they can Transmit as well as Receive the information but Not Simultaneously. At a time, these systems can either transmit or receive.

➤ For example a Transreceiver or walky talky system. The direction of communication alternates.

➤ Also radio communication such as those used in military, fire fighting, citizen band and amateur radio are half duplex system.

FULL DUPLEX SYSTEMS: -

➤ These are truly bidirectional systems as they allow the communication to take place in both directions simultaneously. It can Transmit as well as Receive Simultaneously. For example:-Telephone System.

ANALOG COMMUNICATION SYSTEMS: -

➤ The modulation system or technique in which one of the characteristics of the carrier is varied in proportional with the instantaneous value of the message signal is called Analog Modulation System.

DIGITAL COMMUNICATION SYSTEMS: -

➤ The modulation system or technique in which the transmitted signal is in the form of digital pulses of constant amplitude, constant frequency and phase is called as Digital Modulation System.

BASE BAND TRANSMISSION SYSTEMS : -

➤ The information or the input signal to a communication system can be Analog i.e. Sound, Picture or it can be Digital i.e. the Computer Data.

➤ The electrical equivalent of this original information signal is known as the Base band Signal.

➤ In other words we can define a base band signal is the one which is not modulated.

➤ All the voice, data and picture signals are base band signals.

➤ In Baseband transmission systems, the baseband signals (original signal) are directly transmitted.

➤ Example of these systems is telephone networks where the sound signal converted into the electrical

signal is placed directly on the telephone line for transmission.

➤ Another example of baseband transmission is computer data transmission over coaxial cable in computer networks.

TRANSMISSION SYSTEMS USING MODULATION : -

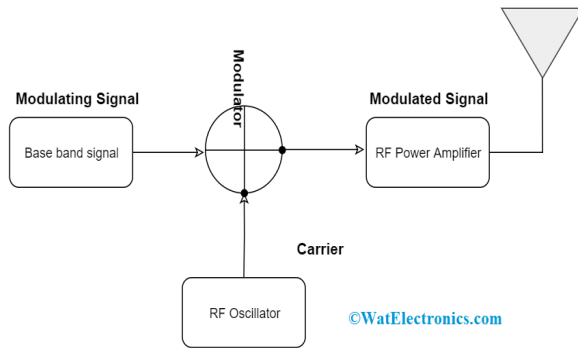

➤ In communication system the transmitter modifies the message signal into a form which is suitable for transmission over channel.

➤ This modification by means of a process of Modulation , which involves varying some parameters of a carrier wave in according with the message signal.

➤ So, modulation may be defined as the process of changing some characteristic (Amplitude or Frequency or Phase) of the Carrier wave according to the intensity (instantaneous value or Amplitude) of the Message signal (Baseband Signal or Audio Signal or Modulating Signal) is known as Modulation.

➤ The resultant waves are known as Modulated Wave.

➤ Message Signal (Audio Signal) + Carrier Wave (High frequency wave) Modulated Wave.

➤ This resulting signal (Modulated Signal) is then transmitted by the transmitter.

➤ The receiver demodulates the received modulated signal and gets the original information signal.

➤ Extraction <To get back of> of message signal from modulated wave is known as demodulation.

❖ NEED OF MODULATION: -

➤ As we know the message signal or baseband signal is used to modulate with a high frequency carrier signal inside the transmitter. After modulation, the resulting modulated wave is transmitted with the help of an antenna which is connected at the output side of the transmitter.

➤ This modulation serves several purposes in communication system as discussed below: -

(1) Reduces Practicality Length of Antenna: -

➤ We know that in case when free space is used as a transmitting medium, messages are transmitted and

received with the help of antennas.

➤ For efficient radiation and reception the transmitting and receiving antennas must have lengths comparable to a quarter-wave length of the frequency used.

➤ Now Let us see by modulation how the length of the antenna can be reduced with an example:-

➤ Let in AM broadcast systems, maximum AF transmitted from a radio station is of the order of 5 KHz.

➤ If this message signal is to be transmitted without modulation, then the height of the antenna required for effective radiation and reception will be $1/4$ th of the wave length given as,

$l = \lambda/4 = c/4f = 3 \times 10^8 / 4 \times 5 \times 10^3 = 15000\text{m} = 15\text{Km}$, Which is practically not possible to construct an antenna.

➤ However , the height of the antenna can be reduced by modulation.

➤ Let after modulation the frequency of the audio signal is increases to higher frequency i.e. radio frequency range let say it is increases up to 5 MHz,

Then $l = \lambda/4 = c/4f = 3 \times 10^8 / 4 \times 5 \times 10^6 = 15\text{m}$, which can practically able to construct.

(2) Avoiding Mixing of Signals during Multiplexing : -

➤ Multiplexing is defined as the simultaneous transmission of various signals through a single channel at a time. The multiplexing allows the same channel to be used by many signals.

➤ If three users are sending three different signals without modulation, as the modulating signals of three users are identical in nature.

➤ So there is a chance of interference or disturbance, which can be avoided by modulation.

➤ After modulation frequencies of three signals are differ from each other by large amount so interference can be avoided by using Modulation.

(3) Increases the Operating Range: -

➤ Energy of wave depends upon frequency. The greater the frequency , greater the energy possessed by it.

➤ The frequency of baseband signal is low and the low frequency signal cannot travel a long distance, so these waves cannot be transmitted over large distance, if radiated directly into space.

➤ The only practical solution is to modulate a high frequency carrier wave with audio signal.

(4) Narrow Banding: -

➤ As the audio signal ranges from 20 Hz-20 KHz. For sending 20 Hz signal and 20 KHz signal we need two antennas with the ratio in height $20,000/20=1,000$. (Which is a large band)

➤ If we add the carrier signal of 10 MHz, then the ratio of height of the antenna will be $(20,000+10\text{MHz})/(20+10\text{MHz})=1.02$ (which is a narrow band after modulation)

(5) Improves Quality of Reception : -

➤ Noise is the major limitation of any communication system.

➤ By modulation the effect of noise is reduced to a great extent. But it cannot be eliminated completely.

➤ This improves quality of reception.

ANALOG AND DIGITAL SIGNALS: -

➤ The Analog Signal is that type of signal which varies smoothly and continuously with time.

➤ This means that analog signals are defined for every value of time and they take on continuous values in a given time interval.

➤ For example speech signal is an analog signal since it has amplitude that varies over a continuous time.

➤ A signal representation is that of a sequence of numbers, each number representing the signal magnitude at an instant of time. The resulting signal is called Digital Signal.

➤ Digital messages are constructed with a finite number of symbols. Since digital signal is represented only by digits, therefore, we can use any number system to represent digital signal.

➤ However , in practice we generally use binary number system to represent digital signal.

➤ The Signal which continuous in both time and amplitude is known as Analog Signal.

➤ The Signal which continuous in Amplitude & discontinuous in Time is known as Discrete Signal.

- The analog signal is converted into discrete time signal by the process known as Sampling.
- The Signal which discontinuous in both time and amplitude is known as Digital Signal.
- The discrete signal is converted into digital signal by the process known as Quantization.

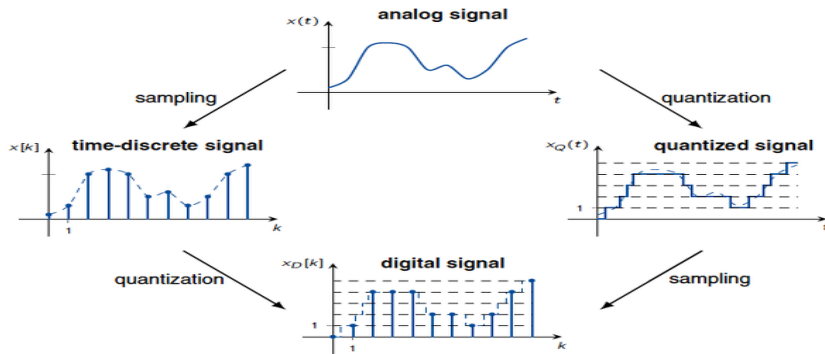

TRANSFORMATION POWER AND CHANNEL BANDWIDTH : -

- In communication system, there are two following two primary factors are employed :
 - ✓ Transmitted Power
 - ✓ Channel bandwidth
- The Transmitted Power refers to the average power of the transmitted Signal.
- The Channel Bandwidth is defined as the band of frequencies allocated for the transmission of the message signal.
- The most important system design objective is to use these two resources as efficiently as possible.
- In most communication channels, one resource may be considered more important than other.
- Because of this we may classify communication channels as Power limited or Band limited.
- Telephone circuit is a typical band limited channel where as a space communication link or satellite channel is typically power limited channel.
- Another important factor is the unavoidable presence of noise in a communication system.
- A quantitative way of accounting for the effect of noise is to introduce signal-to-noise ratio (SNR).
- So we may define SNR at the receiver input as the ratio of the average signal power to the average

noise power, both being measured at the same point.

- In the study of modulation channel bandwidth and signal-to-noise ratio being the two important parameters that are available to the designer of the communication channel.

INFORMATION CAPACITY THEOREM: -

- This is given by Shannon, deals with a continuous channel. According to this theorem, channel bandwidth and SNR are exchangeable for a prescribed system performance and is given by,

$$C = B \log_2(1 + \text{SNR}) \text{ b/s}$$

C=channel capacity

- Where, B → Channel Bandwidth,

SNR → Received Signal-to-Noise ratio &

C → Information Capacity.

- The Information Capacity is defined as the maximum rate at which information may be transmitted without error through channel. It is measured in bits per second (b/s).
- Above equation clearly shows that for a prescribed information capacity, we may reduce

ALL THE BEST

